



#### Product Summary

$V_{(BR)DSS}$	$R_{DS(on)TYP}$	$I_D$
-12V	32mΩ@-4.5V	-4.1A
	45mΩ@-2.5V	
	60mΩ@-1.8V	

#### Feature

- Trench Technology Power MOSFET
- Low  $R_{DS(ON)}$
- Low Gate Charge

#### Application

- Load Switch
- DC/DC Converter

#### MARKING:

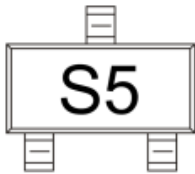

#### SOT-23

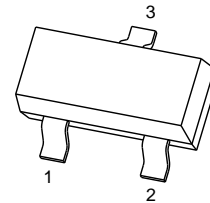

1. GATE
2. SOURCE
3. DRAIN

#### Schematic diagram

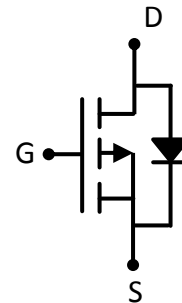

#### ABSOLUTE MAXIMUM RATINGS ( $T_A=25^{\circ}C$ unless otherwise noted)

Parameter	Symbol	Value	Unit
Drain-Source Voltage	$V_{DS}$	-12	V
Gate-Source Voltage	$V_{GS}$	$\pm 10$	V
Continuous Drain Current	$I_D$	-4.1	A
Pulsed Drain Current ( $t=300\mu s$ )	$I_{DM}$	-15	A
Power Dissipation	$P_D$	0.35	W
Thermal Resistance from Junction to Ambient	$R_{\theta JA}$	357	$^{\circ}C/W$
Junction Temperature	$T_J$	150	$^{\circ}C$
Storage Temperature	$T_{STG}$	-55~ +150	$^{\circ}C$

**MOSFET ELECTRICAL CHARACTERISTICS (T<sub>A</sub> = 25°C unless otherwise noted)**

Parameter	Symbol	Test Condition	Min	Type	Max	Unit
<b>Off Characteristics</b>						
Drain-Source Breakdown Voltage	V <sub>(BR)DSS</sub>	V <sub>GS</sub> = 0V, I <sub>D</sub> = -250μA	-12			V
Zero Gate Voltage Drain Current	I <sub>DSS</sub>	V <sub>DS</sub> = -12V, V <sub>GS</sub> = 0V			-1	μA
Gate-Body Leakage Current	I <sub>GSS</sub>	V <sub>GS</sub> = ±10V, V <sub>DS</sub> = 0V			±100	nA
<b>On Characteristics<sup>3</sup></b>						
Gate Threshold Voltage	V <sub>GS(th)</sub>	V <sub>DS</sub> = V <sub>GS</sub> , I <sub>D</sub> = -250μA	-0.5	-0.65	-0.9	V
Drain-Source On-Resistance	R <sub>DS(on)</sub>	V <sub>GS</sub> = -4.5V, I <sub>D</sub> = -3.5A		32	45	mΩ
		V <sub>GS</sub> = -2.5V, I <sub>D</sub> = -3.0A		45	60	
		V <sub>GS</sub> = -1.8V, I <sub>D</sub> = -2.0A		60	90	
Forward Transconductance	g <sub>FS</sub>	V <sub>DS</sub> = -5V, I <sub>D</sub> = -4.1A	6			S
<b>Dynamic Characteristics<sup>4</sup></b>						
Input Capacitance	C <sub>iss</sub>	V <sub>DS</sub> = -6V, V <sub>GS</sub> = 0V, f = 1MHz		697		pF
Output Capacitance	C <sub>oss</sub>			119		
Reverse Transfer Capacitance	C <sub>rss</sub>			116		
Gate Resistance	R <sub>g</sub>	V <sub>DS</sub> = 0V, V <sub>GS</sub> = 0V, f = 1MHz		192		Ω
<b>Switching Characteristics<sup>4</sup></b>						
Total Gate Charge	Q <sub>g</sub>	V <sub>DS</sub> = -10V, V <sub>GS</sub> = -4.5V, I <sub>D</sub> = -3.5A		8.5		nC
Gate-Source Charge	Q <sub>gs</sub>			0.8		
Gate-Drain Charge	Q <sub>gd</sub>			2.7		
Turn-On Delay Time	t <sub>d(on)</sub>	V <sub>DD</sub> = -4V, V <sub>GEN</sub> = -4.5V, R <sub>G</sub> = 1Ω, I <sub>D</sub> = -3.3A		13		ns
Turn-On Rise Time	t <sub>r</sub>			35		
Turn-Off Delay Time	t <sub>d(off)</sub>			32		
Turn-Off Fall Time	t <sub>f</sub>			10		
<b>Source-Drain Diode Characteristics</b>						
Diode Forward Current	I <sub>S</sub>	T <sub>C</sub> = 25°C			-4.1	A
Diode Pulsed Forward Current	I <sub>SM</sub>	T <sub>C</sub> = 25°C			-15	A
Diode Forward Voltage <sup>3</sup>	V <sub>SD</sub>	V <sub>GS</sub> = 0V, I <sub>S</sub> = -3.3A			-1.2	V

Notes :

1. The maximum current rating is limited by package.
2. Pulse Test : Pulse Width ≤ 10μs, duty cycle ≤ 1%.
3. Pulse Test : Pulse Width ≤ 300μs, duty cycle ≤ 2%.
4. The power dissipation P<sub>D</sub> is limited by T<sub>J(MAX)</sub> = 150°C.
5. Device mounted on 1in<sup>2</sup> FR-4 board with 2oz. Copper, in a still air environment with T<sub>A</sub> = 25°C.

**Typical Electrical and Thermal Characteristics**

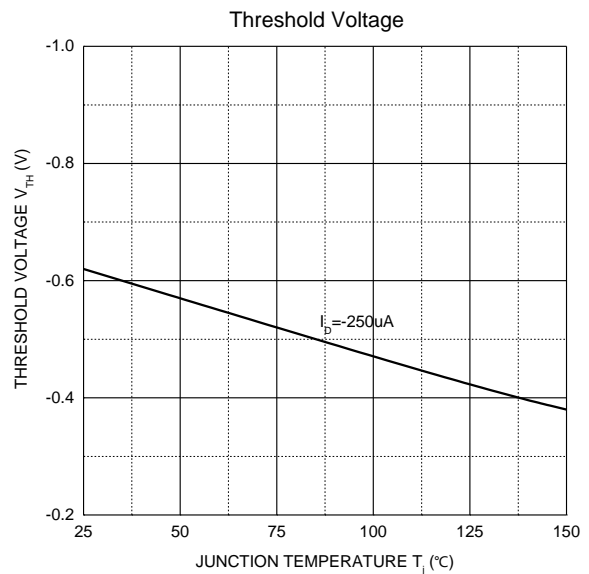
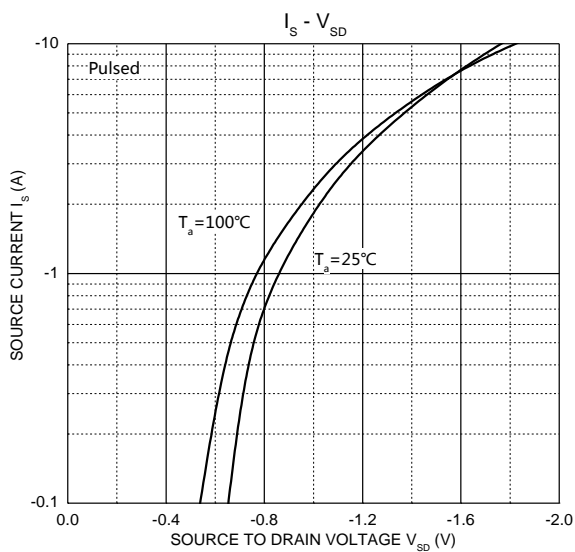
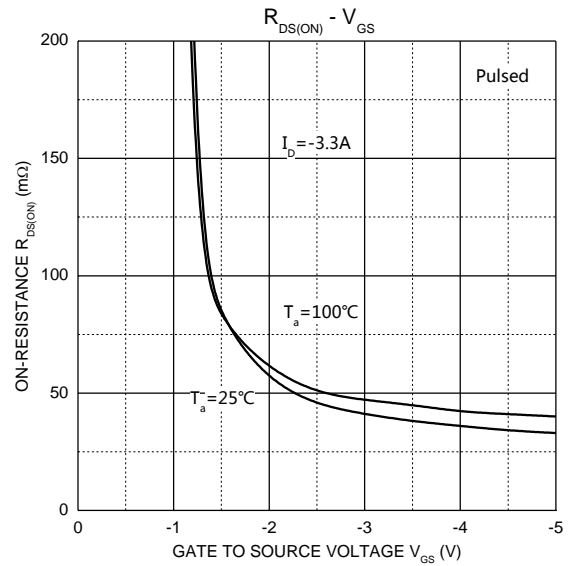
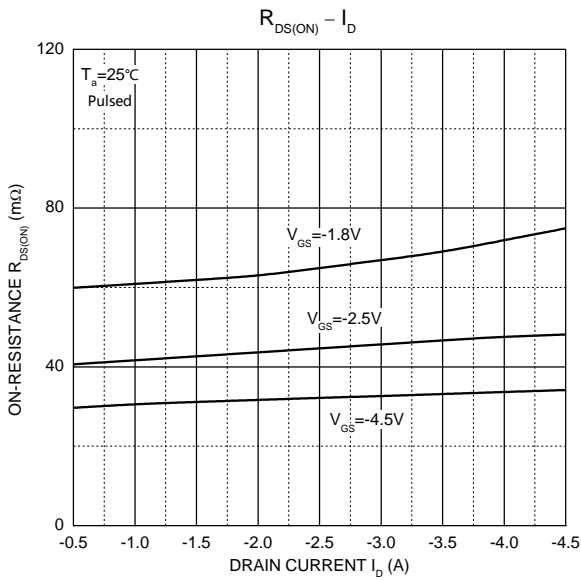
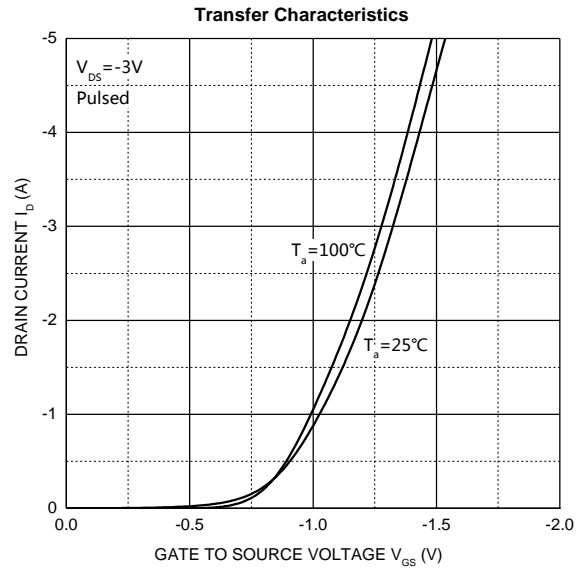
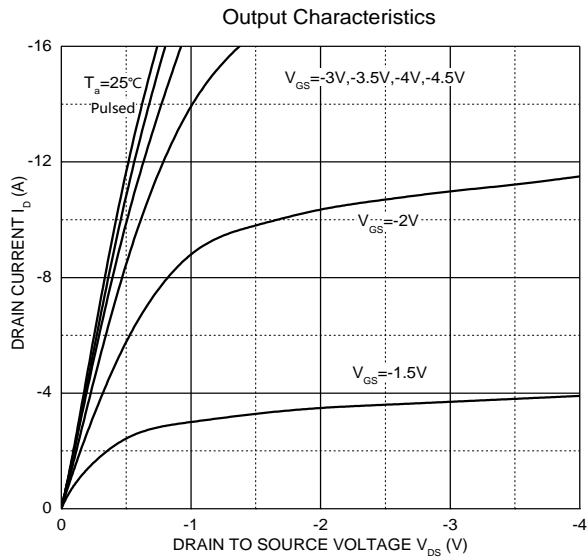

## SOT-23 Package Information

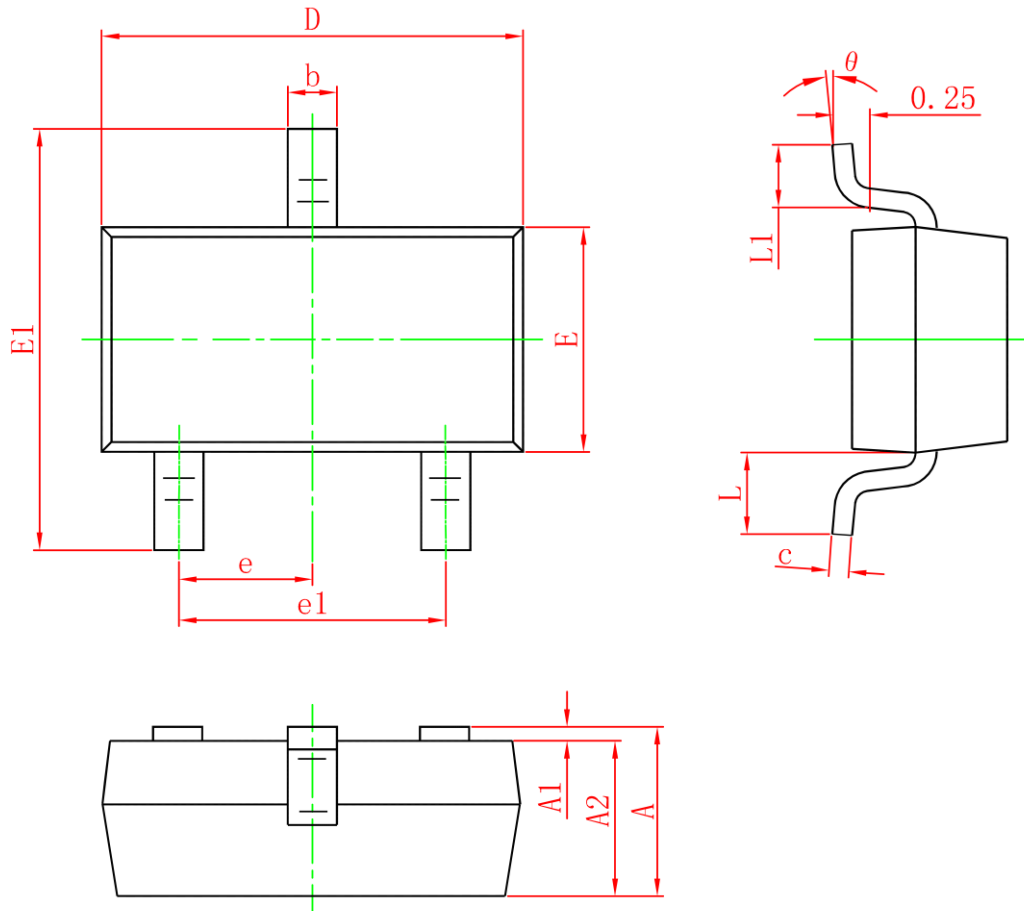

Symbol	Dimensions In Millimeters		Dimensions In Inches	
	Min.	Max.	Min.	Max.
A	0.900	1.150	0.035	0.045
A1	0	0.100	0	0.004
A2	0.900	1.050	0.035	0.041
b	0.300	0.500	0.012	0.020
c	0.080	0.150	0.003	0.006
D	2.800	3.000	0.110	0.118
E	1.150	1.500	0.045	0.059
E1	2.250	2.650	0.089	0.104
e	0.950TYP		0.037TYP	
e1	1.800	2.000	0.071	0.079
L	0.550REF		0.022REF	
L1	0.300	0.500	0.012	0.020
$\theta$	0°	8°	0°	8°

**Attention:**

- GreenPower Electronics reserves the right to improve product design function and reliability without notice.
- Any and all semiconductor products have certain probability to fail or malfunction, which may result in personal injury, death or property damage. Customer are solely responsible for providing adequate safe measures when design their systems.
- GreenPower Electronics products belong to consumer electronics or other civilian electronic products.